

# Data Sheet



Article number: 2302166162

Description: E+G Lobe knobs  
VC.692/25 SST-p-M5x16

## Measures

---

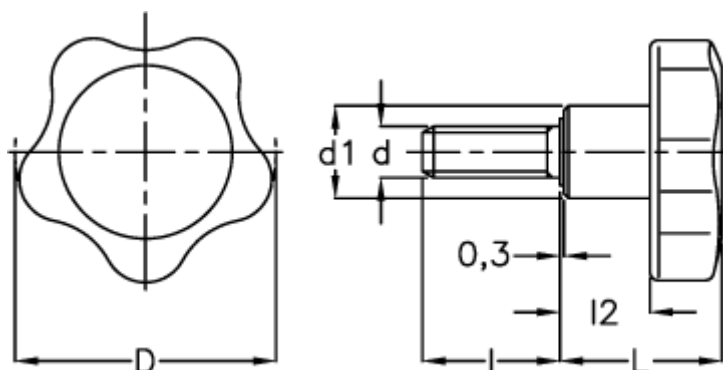

D	= 25
d1	= 12
d 6g	= M5
l	= 16
L	= 20
l2	= 10